

JET Forward Programme & Opportunities for Collaboration

Lorne Horton
JET Exploitation Manager



European
Commission

Contract for the Operation of the JET Facilities Co-Funded by Euratom



CCFE
CULHAM CENTRE FOR
FUSION ENERGY

- **What makes JET unique**
- **Plans for JET exploitation**
- **Potential areas for collaboration**
- **Summary**

- **What makes JET unique**
- **Plans for JET exploitation**
- **Potential areas for collaboration**
- **Summary**

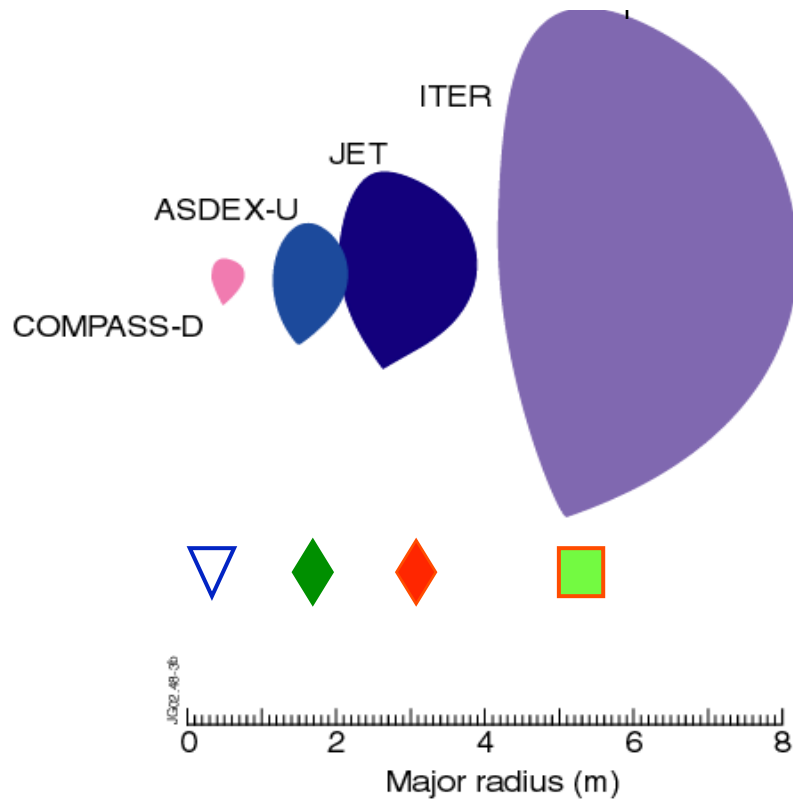

Fusion research profits from a step ladder approach based on devices of different size but similar magnetic configuration

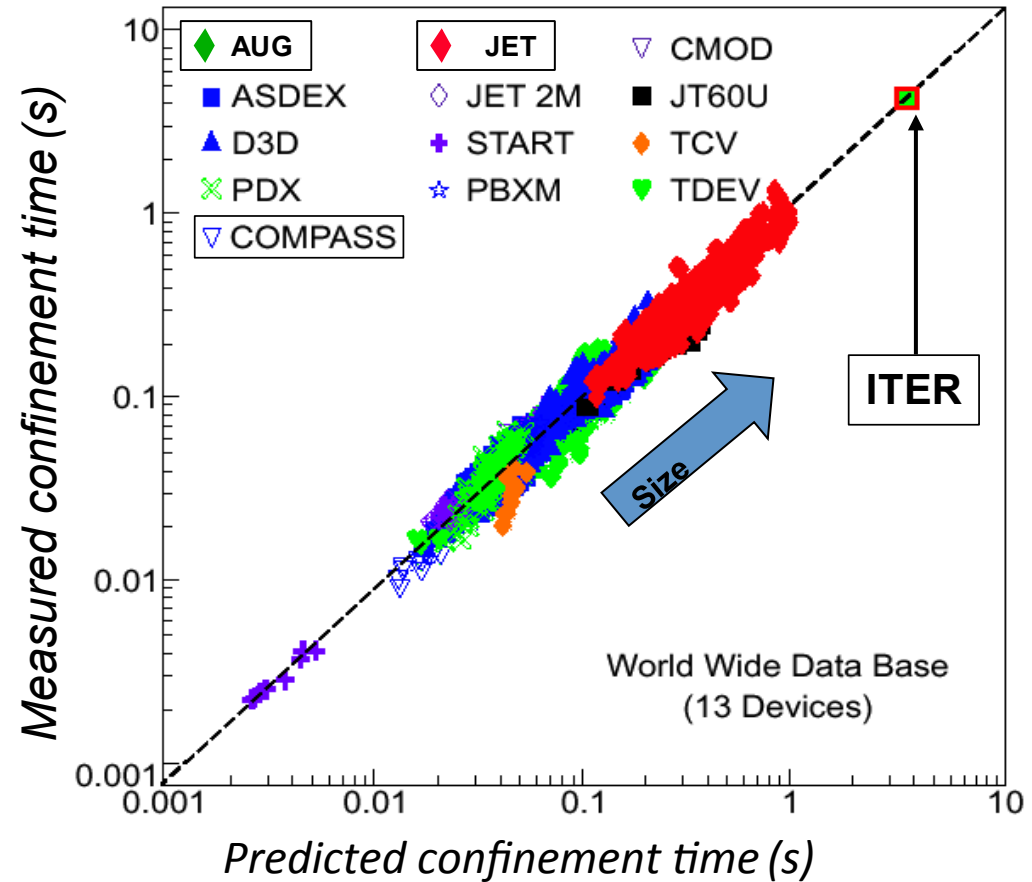

This approach has allowed the full qualification of the baseline regime of operation of ITER: the H-mode

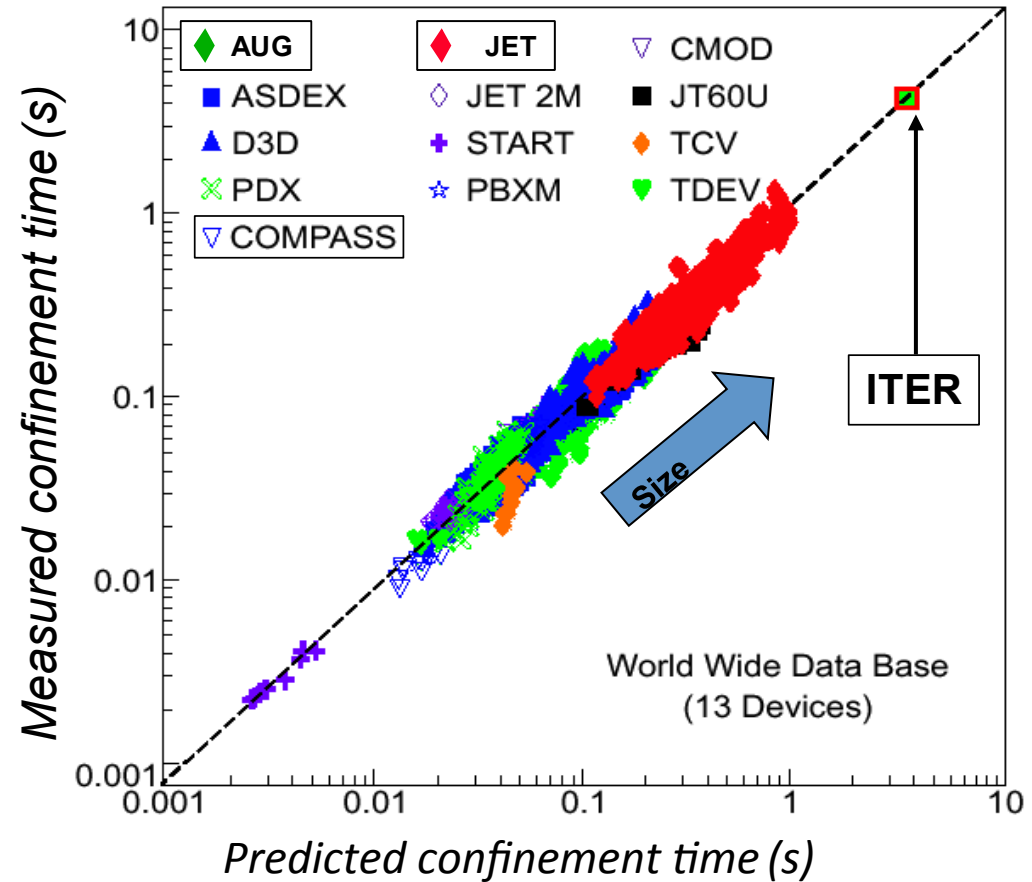
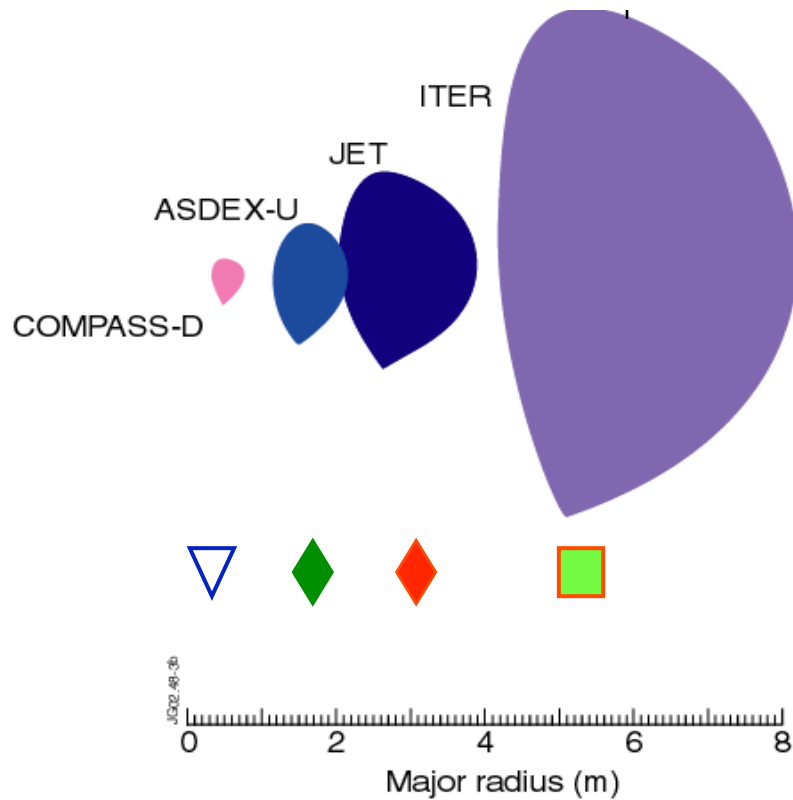

JET provides the point closest to ITER for the extrapolation of H-mode confinement

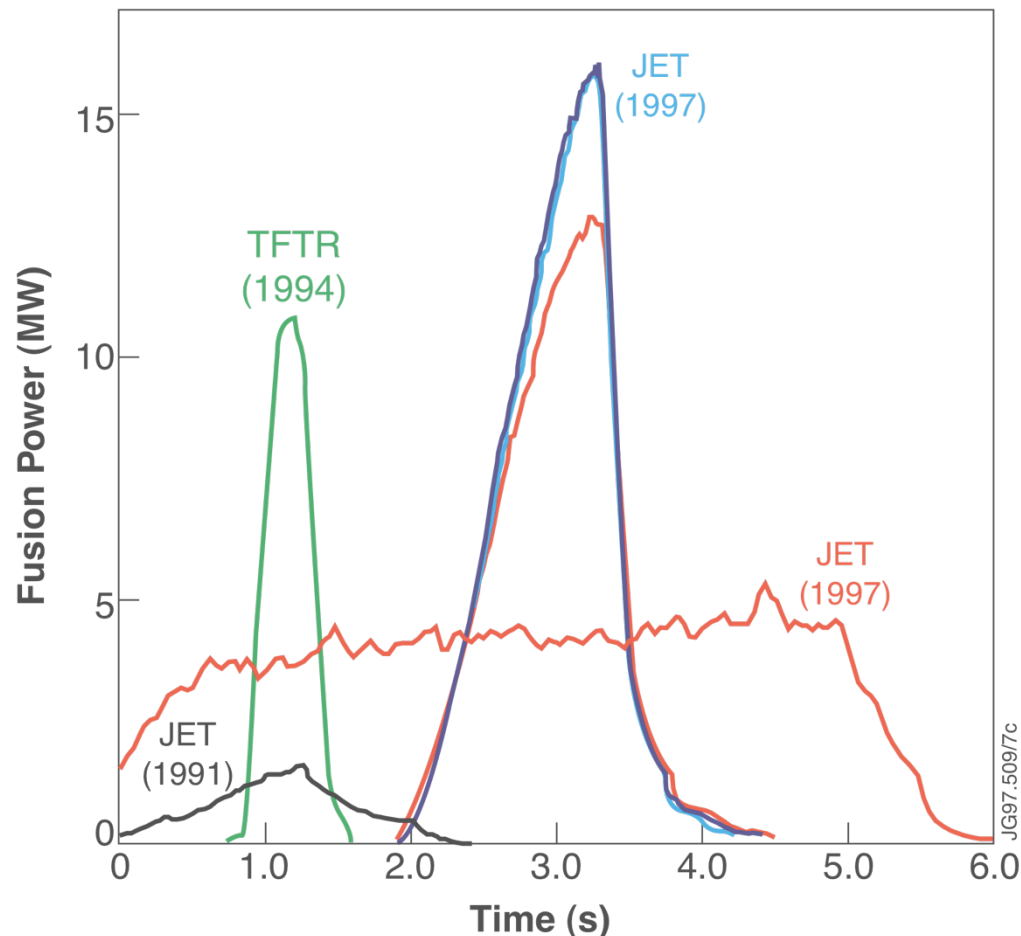

- A number of unexpected discoveries during the 1997 tritium campaign
 - Isotope effect on confinement
 - Difference in edge conditions
- Need to minimize the risk of delays in ITER exploitation at the start of the tritium phase.
 - Effect of wall materials?
- Most of neutron budget still available
 - 3×10^{20} neutrons in DTE1
 - **2×10^{21} total budget**

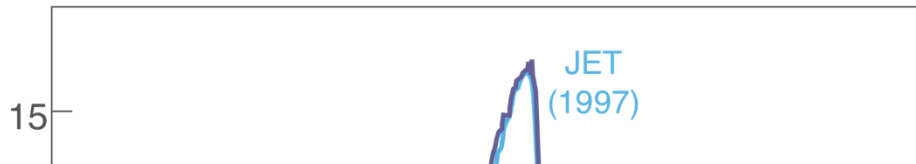

- A number of unexpected discoveries during the 1997 tritium campaign

Test ITER operation regimes with tritium about 10 years before first ITER DT experiment



- 3×10^{20} neutrons in DTE1
- 2×10^{21} total budget

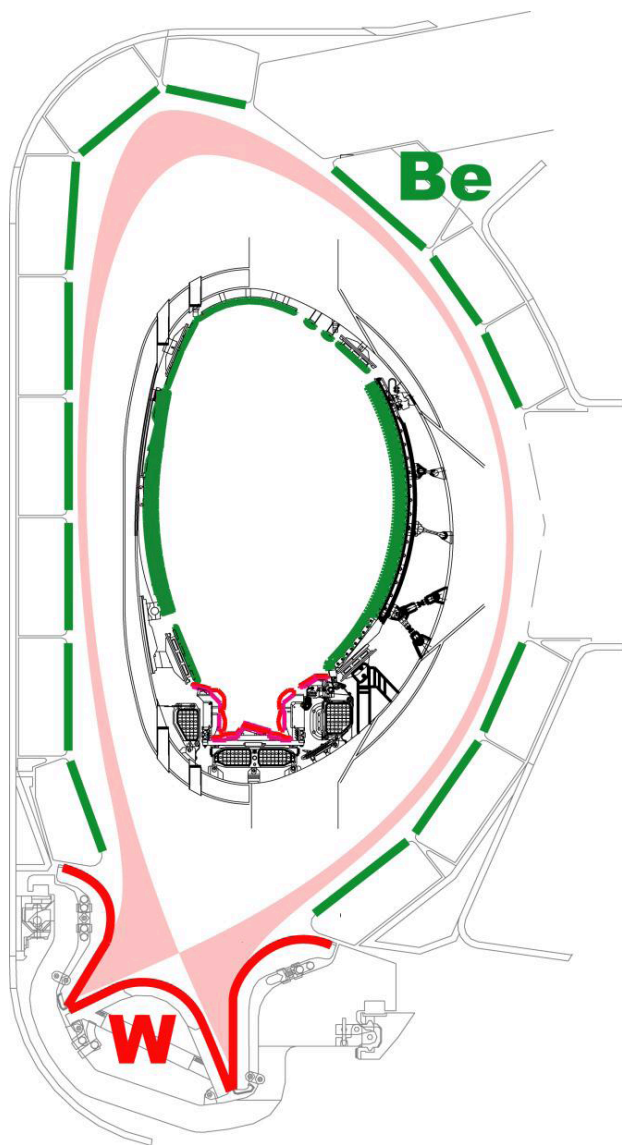

ITER proposes to start operation with a beryllium wall and tungsten for the divertor.

- This material mix is being tested for the first time in JET
- ITER-like wall (beryllium plus tungsten) has been installed in JET, together with:
 - Increased NB heating power: from 20 MW short pulse to 30 MW long pulse
 - Improved control capabilities
 - Improved diagnostics
- **JET is the only machine with the same plasma facing materials of ITER**

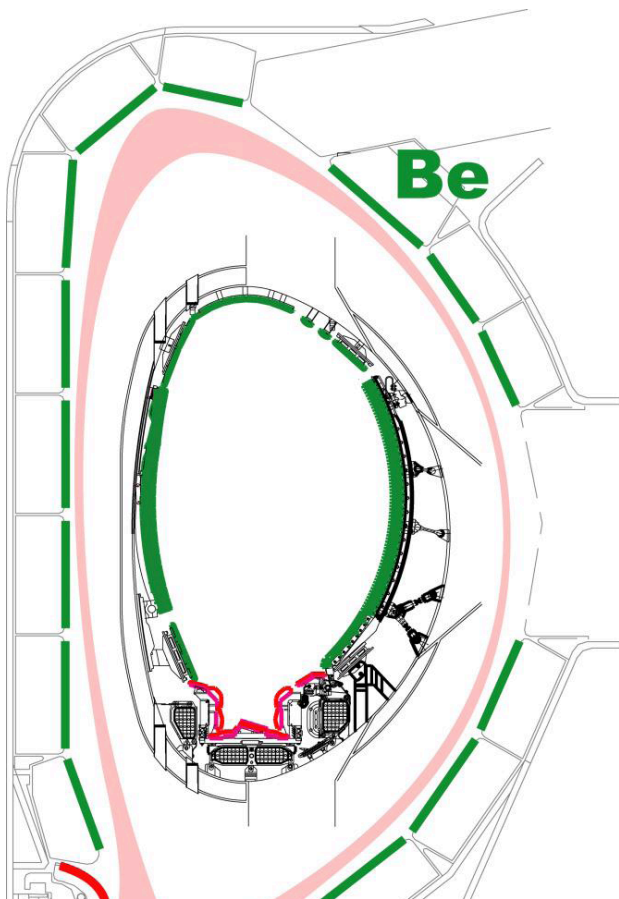

ITER proposes to start operation with a beryllium wall and tungsten for the divertor.

- This material mix is being tested for the first time in JET
- ITER-like wall (beryllium plus tungsten) has been installed in JET, together with:
 - Increased NB heating power: from 20 MW short pulse to 30 MW long pulse
 - Improved control capabilities
 - Improved diagnostics
- **JET is the only machine with the same plasma facing materials of ITER**

Risk minimization of the ITER exploitation and possible cost reduction

[Brezinsek, PSI 2014]

- Very low residual C content in the plasma – high plasma purity
- ILW is a good approximation of conditions to be expected in ITER starting with Be/W

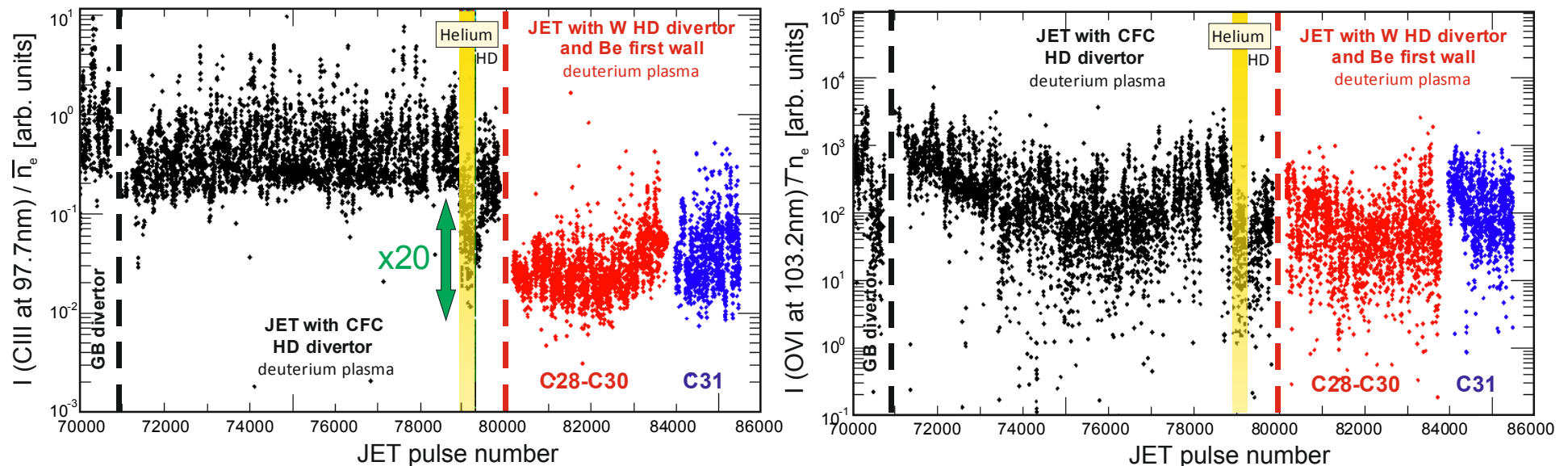

- Average Z_{eff} dropped from 2.0 (JET-C) to 1.2-1.4 (JET-ILW)

➤ Many operational consequences (expected and unexpected)

- The dynamics of disruptions are very different with the ILW
 - Higher plasma purity → lower radiation during disruption
 - slower current quench
 - higher heat loads and halo currents
 - higher reaction forces on the vessel

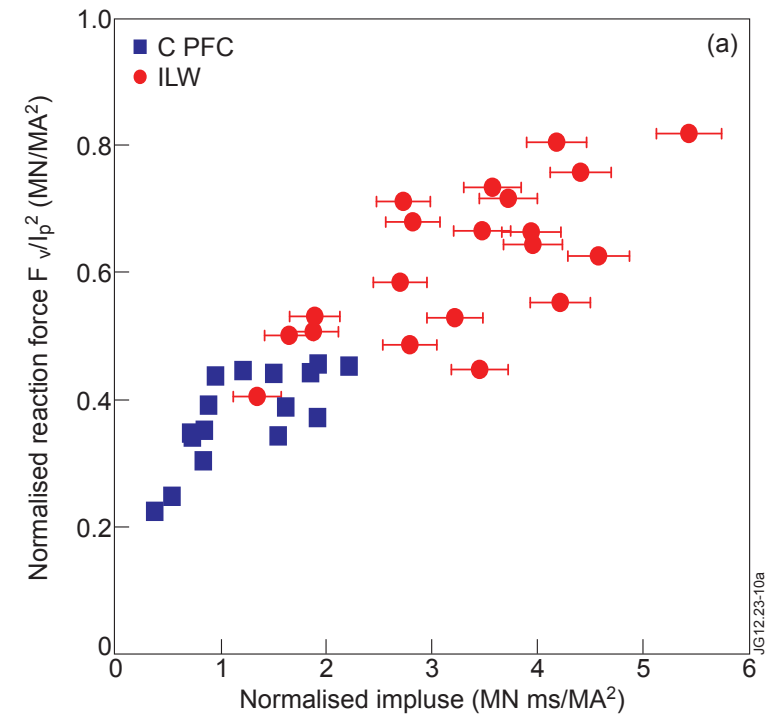
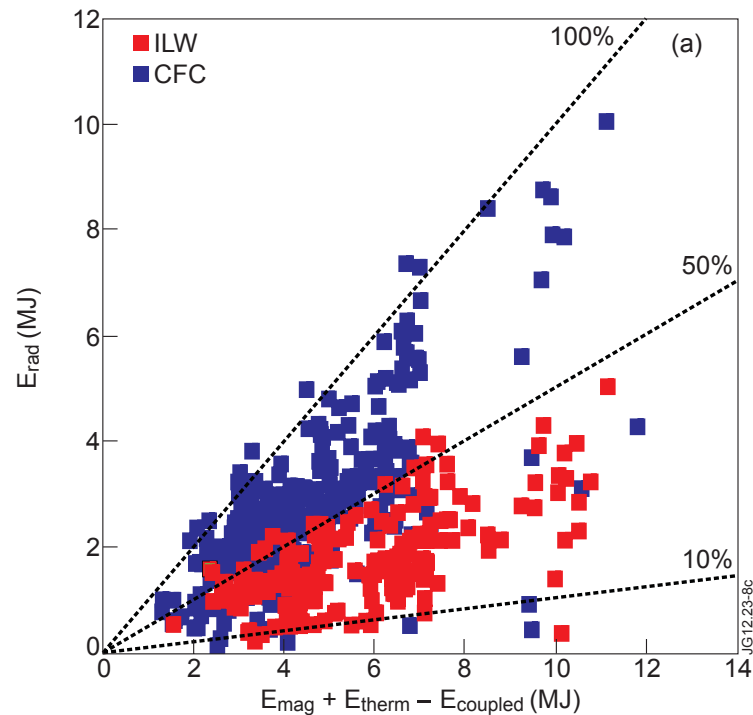

[Lehnen, J. Nucl. Mater. 438, S102 (2013)]

- Massive gas injection as a disruption mitigation tool is now mandatory for JET experiments at or above 2.5 2.0 MA.
- With the mitigation, the forces and power loads resulting from disruptions are returned to the level observed with C wall

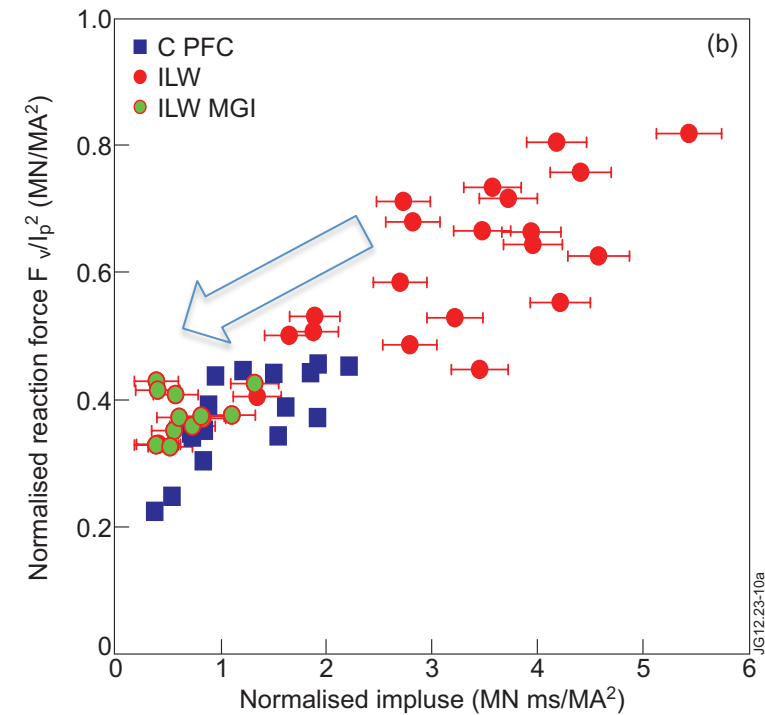
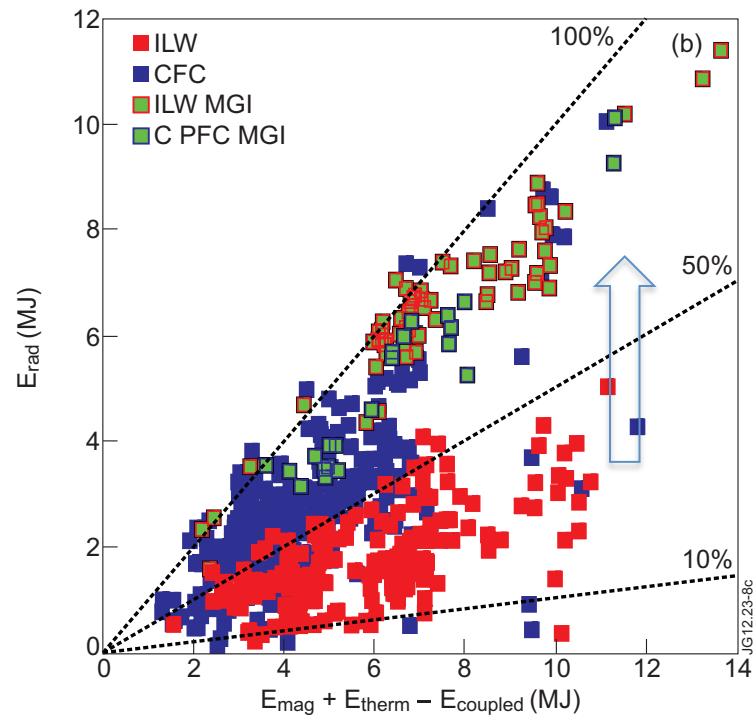

[Lehnen, J. Nucl. Mater. 438, S102 (2013)]

- What makes JET unique
- **Plans for JET exploitation**
- Potential areas for collaboration
- Summary

[J. Paméla, Fusion Eng. Des. 82 (2007) 590]

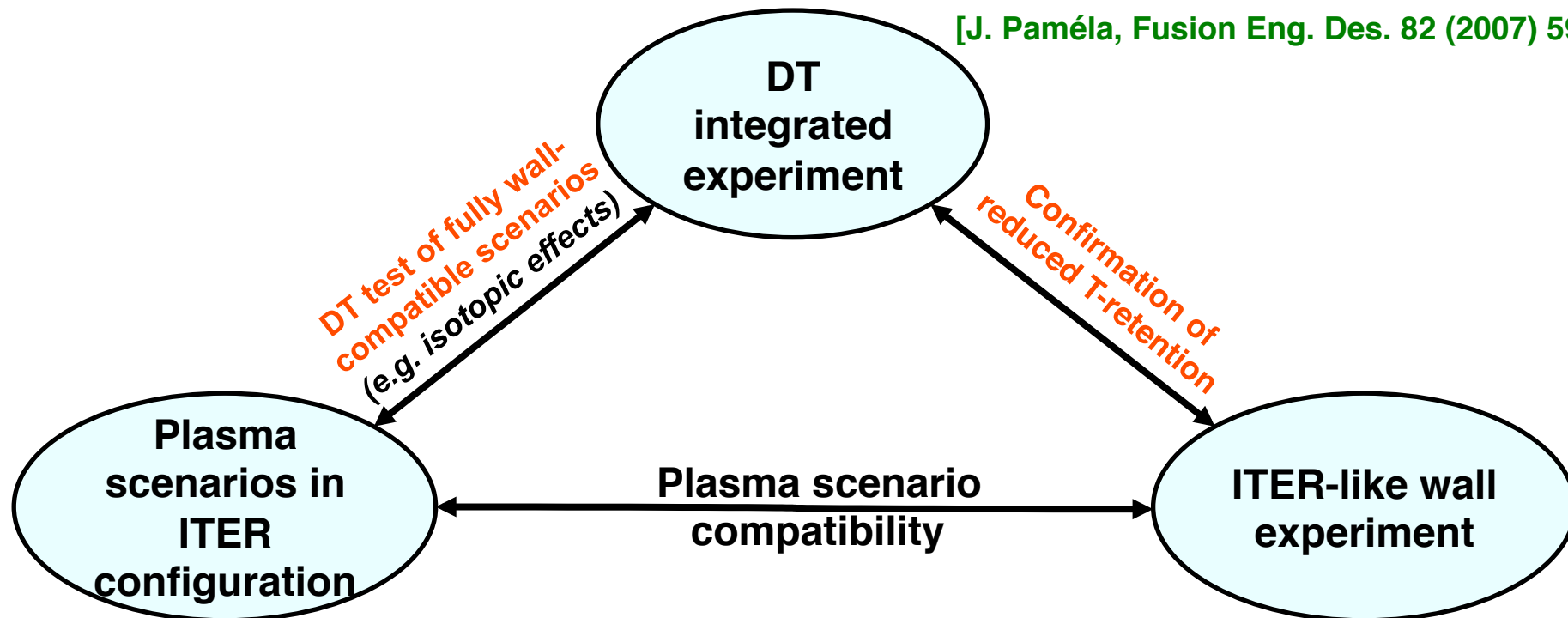

- **Phase 1: 2011-2012** (Deuterium Operation)
“Full Characterisation of the ITER-like Wall”
- **Phase 2: 2013-2015** (Deuterium* Operation)
“Expansion of ITER Regimes of Operation”
- **Phase 3: 2017**
“Deuterium-Tritium Campaigns”

There are two possible scenarios for the future use of JET:

Reference Scenario:

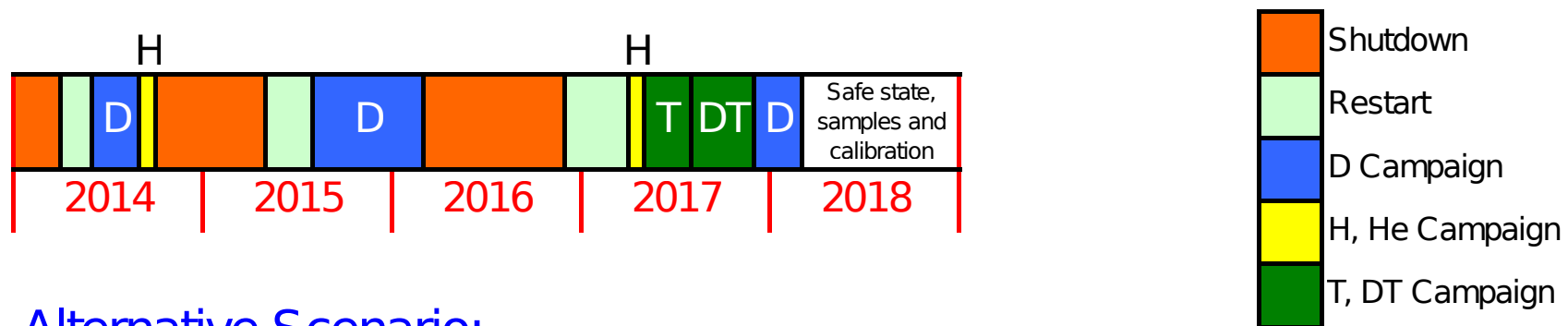

Alternative Scenario:

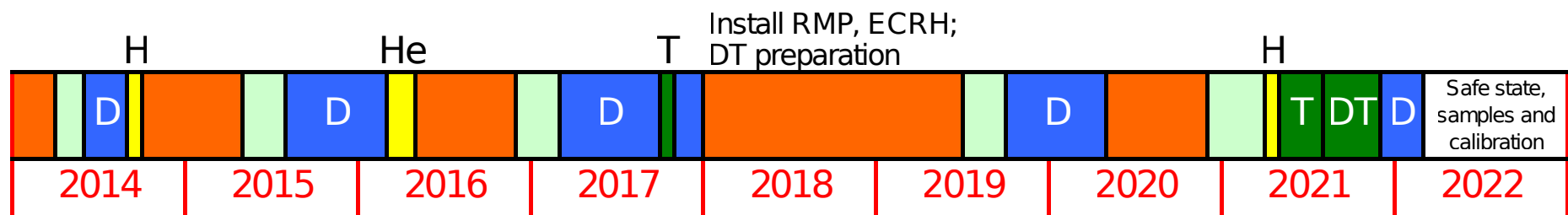

*Details of the Alternative Scenario are not yet agreed

There are two possible scenarios for the future use of JET:

Reference Scenario:

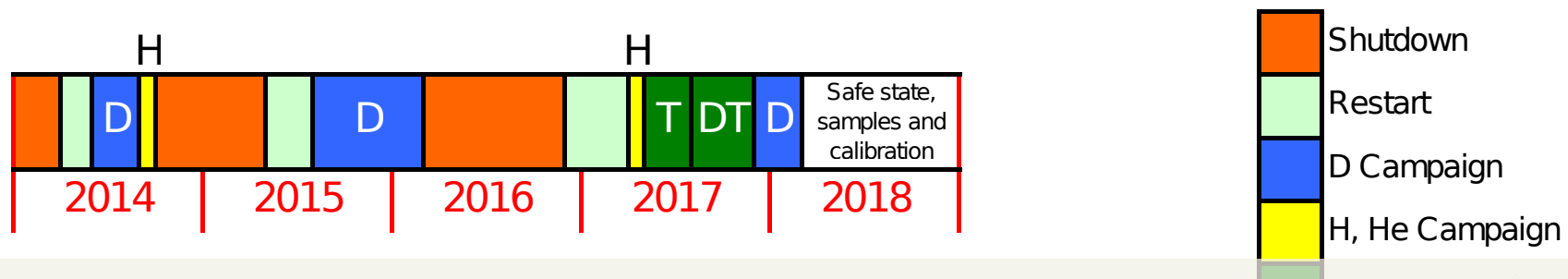

Reference Scenario will validate the ITER design choice for the plasma facing materials and will prepare the ITER operation in view of first DT plasma



*Details of the Alternative Scenario are not yet agreed

There are two possible scenarios for the future use of JET:

Reference Scenario:

Alternative Scenario will provide the support for the ITER decision on the upgrade of the heating systems in view of ITER Phase II (blanket test) and DEMO

Alternative Scenario:

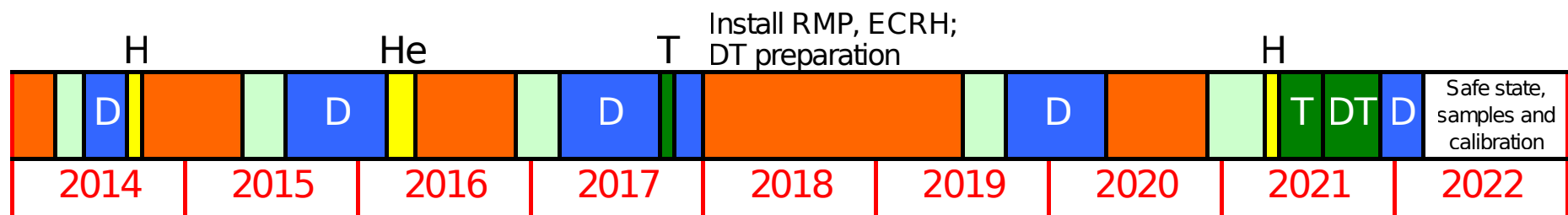

*Details of the Alternative Scenario are not yet agreed

- What makes JET unique
- Plans for JET exploitation
- **Potential areas for collaboration**
- Summary



- Inside the Reference Scenario, the focus of the JET programme will be on **nuclear operation**. There is an opportunity for American scientists and engineers to participate in the programme as preparation for ITER operation.
- Participation in the JET scientific programme would prepare American scientists for nuclear operation in ITER
 - Operation compatible with tritium safety;
 - Burning plasma physics, including alpha transport and, potentially, fast ion instabilities;
 - Isotope physics (core transport, edge stability, L-H transition);



- Inside the Alternative Scenario, there would be much greater opportunity to train international scientists and engineers and integrate them into the JET Team
 - Training as a JET session leader requires ~3 years;
 - Key Operator roles, including possibly Engineer-in-Charge (responsible for overall operation of the machine)
- The proposed upgrades to JET would provide unparalleled access to regimes of operation as close as possible to those foreseen in ITER
 - **Resonant Magnetic Perturbation Coils** for ELM control;
 - **Electron Cyclotron Current Drive** system;

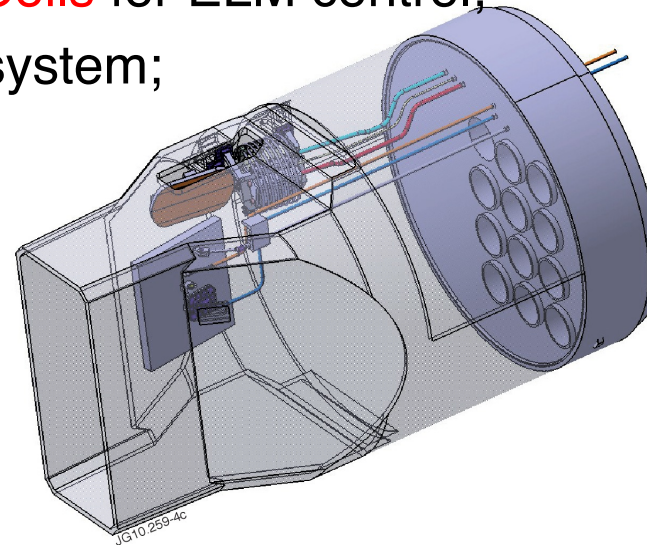
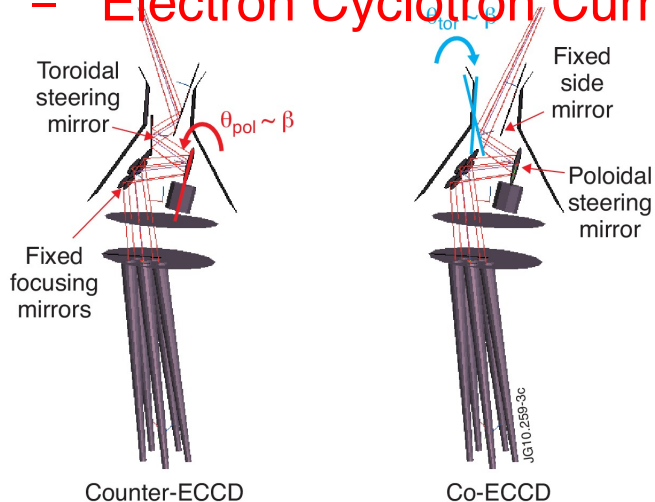



Various levels of participation in the JET programme are possible.

- These range from:

Collaborations on specific areas of mutual interest with international scientists participating in the JET programme on an *ad personam* basis, e.g.:

- ✧ Edge CXRS diagnostics and related physics;
- ✧ TRANSP support for JET confinement analysis;
- ✧ Fast particle-wave interactions and Alfvén eigenmodes;

We expect such on-going collaborations to continue into our DT programme

Various levels of participation in the JET programme are possible.

- To:

Participation as a full partner with EU fusion labs:

- ✧ Definition of programme priorities;
- ✧ Detailed definition of experiments and supporting scientific tasks;
- ✧ Participation in fusion technology areas related to plasma-surface interactions and the technological exploitation of DT operation;

This would have to be seen against a fair contribution to the ~60 M€ per year operating cost of JET. Such contribution could be via a combination of cash, in-kind contributions for specific hardware and provision of long-term (>~ 2 years) personnel visits to support to JET operations

- JET is unique
 - For its multinational exploitation → template for ITER
 - For its size → close to ITER physics
 - For the use of tritium → ITER operation/technologies
 - For the use of Beryllium → ITER materials
- JET would be an ideal device to train the scientists and engineers who will exploit ITER
- Extended use of JET with the proposed upgrades would:
 - Provide the platform for further international collaboration on the physics of advanced regimes of tokamak operation and on fusion nuclear operation and technology.
 - Provide a unique opportunity to train the ITER Team in operation of a nuclear tokamak in advance of active operation in ITER.

- **What makes JET unique**
- **Plans for JET exploitation**
- **Potential areas for collaboration**
- **Summary**

- The lower H-mode threshold in DT meant that ITB scenarios developed in DD were not optimum in DT
- This is likely to be even more the case in going from the non-active to active phase in ITER
- The increased neutron budget in DTE2 will allow optimisation of scenarios in all isotope mixtures and better extrapolations, both from JET to ITER and from ITER non-active to active

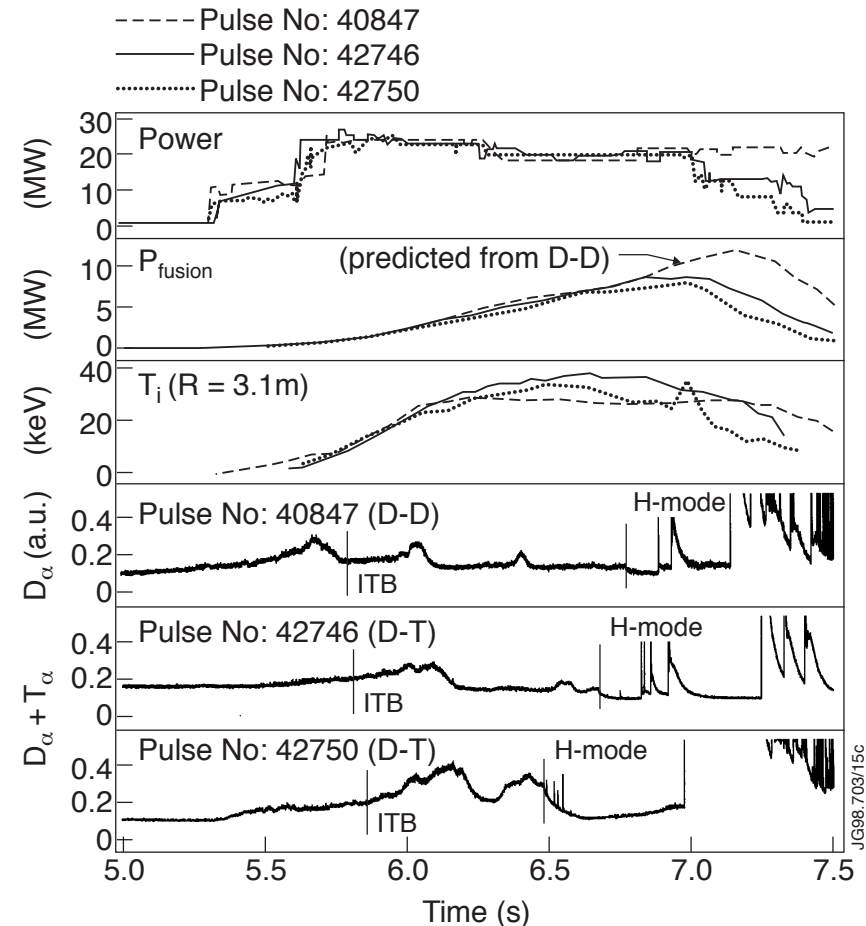

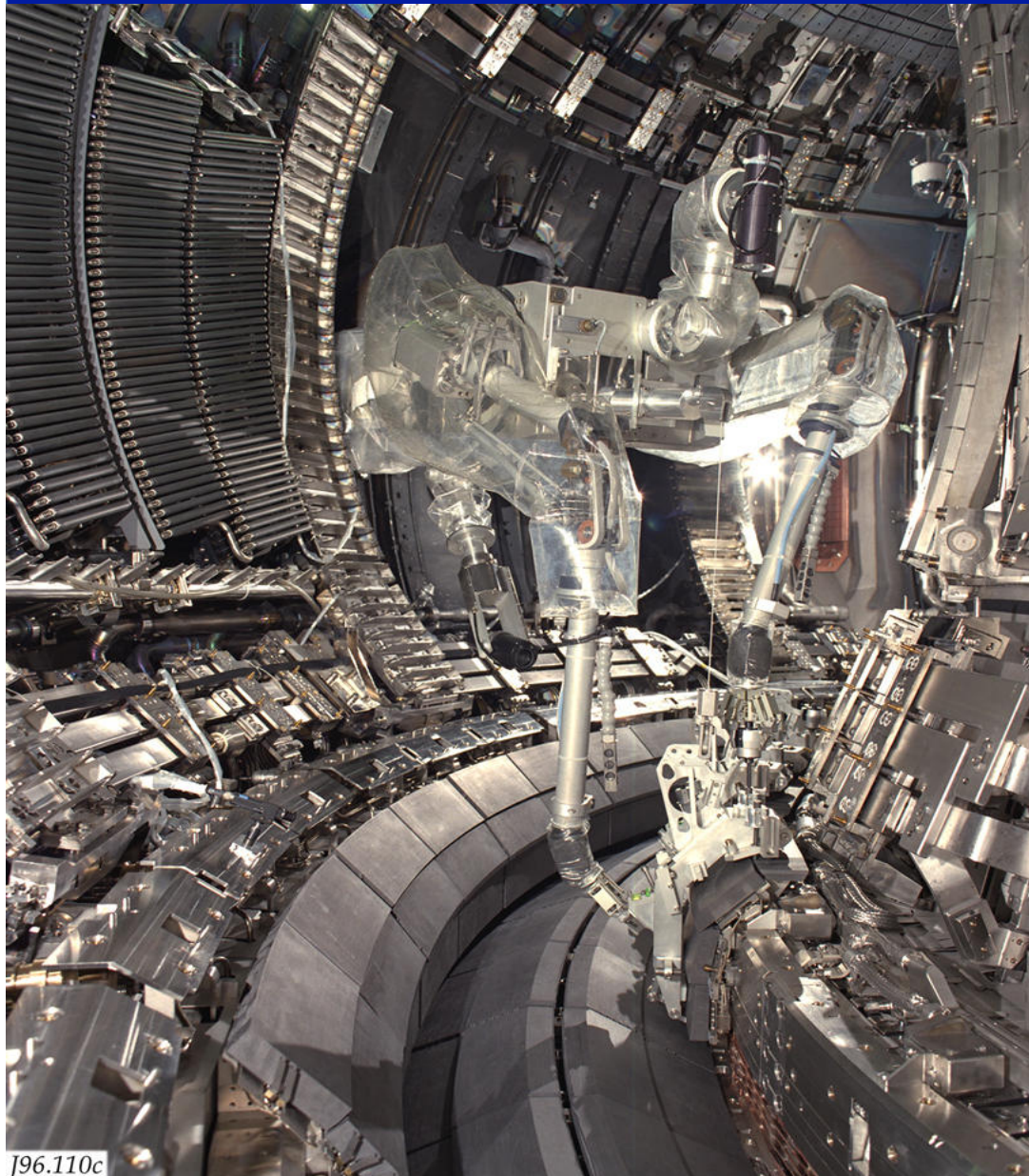

J96.110c

- ***JET has developed and tested technologies relevant for a nuclear plant***
 - Design for high technology and hostile environments;
 - Analysis of structural integrity, fatigue life and reliability;
 - Electro-mechanical and thermo-mechanical analyses and thermo-hydraulics;
 - Remote handling for installation and maintenance;
 - Handling, storage and disposal of radioactive materials, including tritium.



- *JET has developed and tested technologies relevant for a nuclear*

Large know-how available for the ITER construction and training of ITER operators

Test and validation of ITER operational requirements with tritium (codes for activation and occupational dose, tritium removal techniques, etc.)

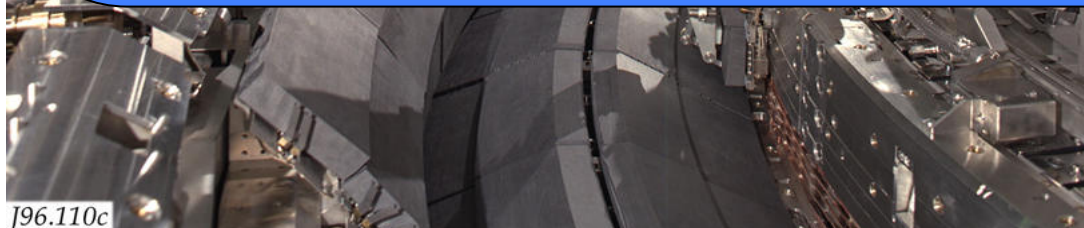

disposal of radioactive materials, including tritium.

J96.110c



Gas Balances used for ITER tritium retention predictions and input to Walldyn

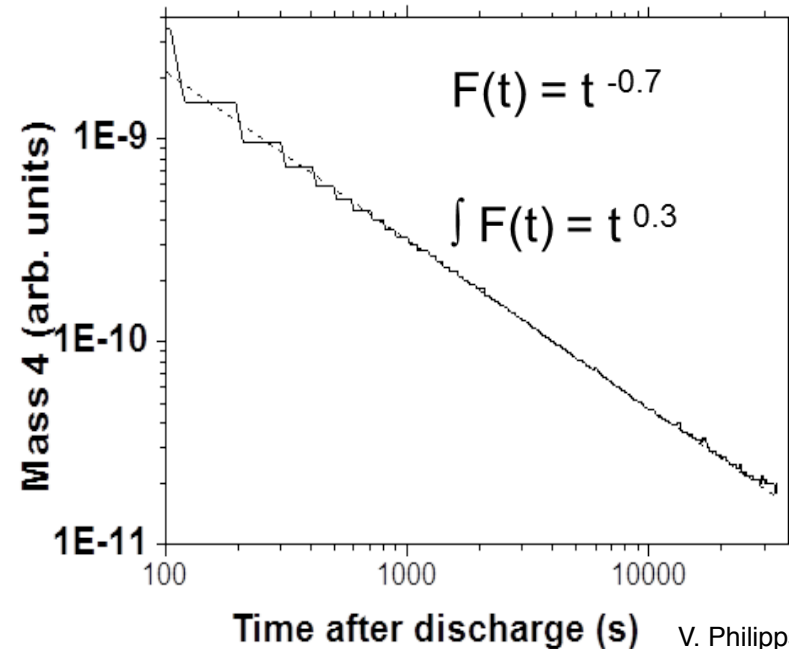
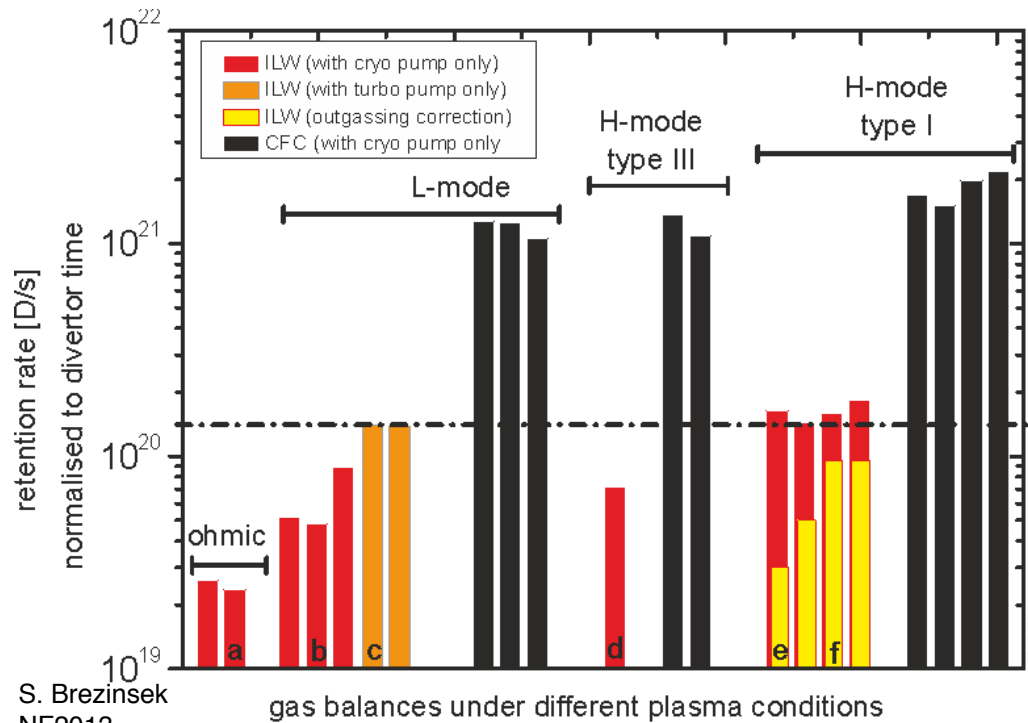

V. Philipps
PFMC 2013

- Reduction of fuel retention rate by more than one order magnitude
- Long-term retention mechanism: implantation and co-deposition (dominant)
- Reasons for the reduction from JET-C to JET-ILW:
 - Be primary source and Be transport to divertor smaller than C in JET-C
 - Lower fuel content in pure Be co-deposits in comparison with C co-deposits
- Integral outgassing comparable between JET-C and JET-ILW

[Maggi/Meyer, EPS 2014]

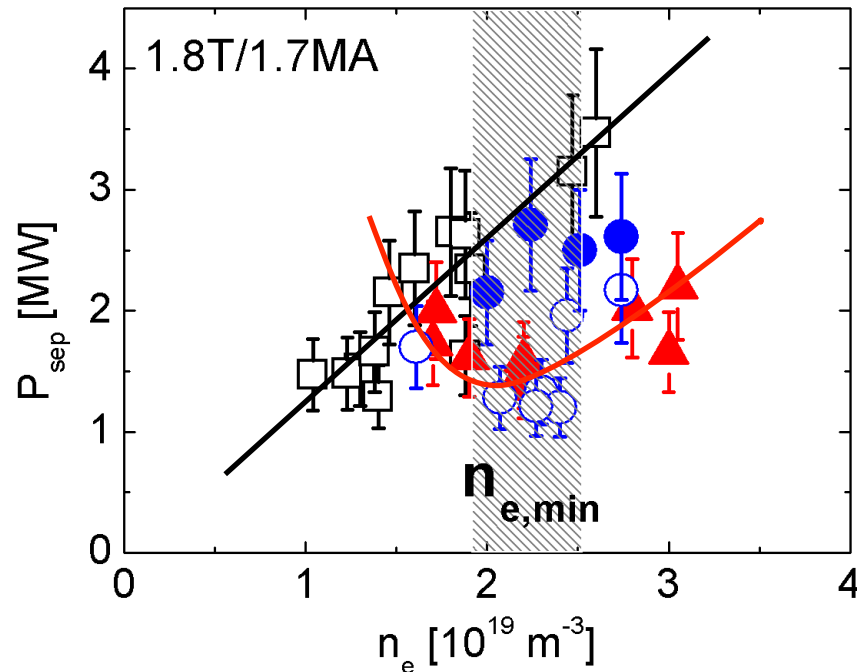

□ JET-C
 JET-ILW:
 ▲ unseeded
 ○ no or low N
 ● high N

- N_2 seeding increases $P_{\text{L-H}}$ when N level is sufficiently high ($\Delta Z_{\text{eff}} \sim 1$)
- Can reach $P_{\text{L-H}}$ values typical of JET-C

- We are exploring 2 mechanisms:
 - The effect of low-Z impurities on the stability of the background edge turbulence [Bourdelle, NF Lett 54 (2014) 022001]
 - Changes in divertor and SOL radiation patterns when C is strongly reduced → affect edge heat fluxes regulating the L-H transition?

- Confinement with JET-ILW (and AUG) degraded w.r.t. carbon wall
- Partly due to fuelling requirements to avoid W accumulation
- Driven by changes in the pedestal
- Pedestal recovery possible by increasing β_N or by impurity seeding

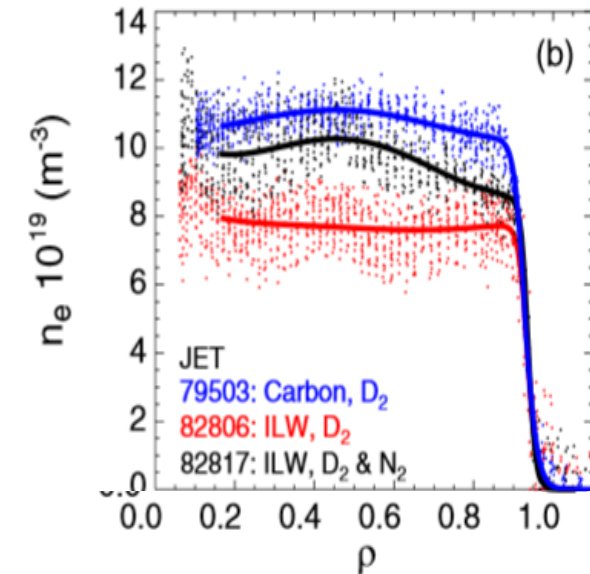
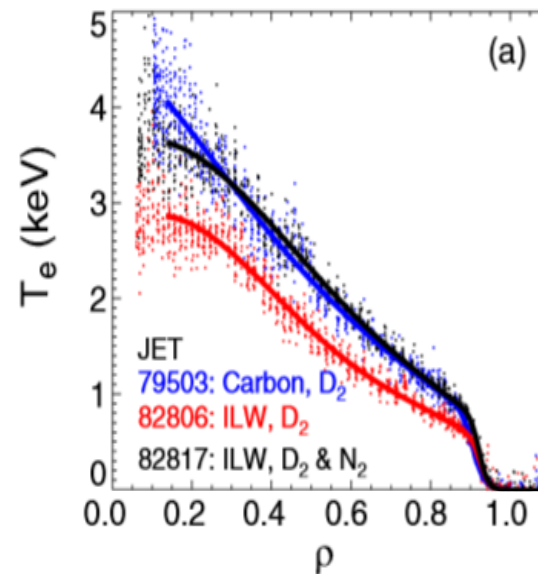
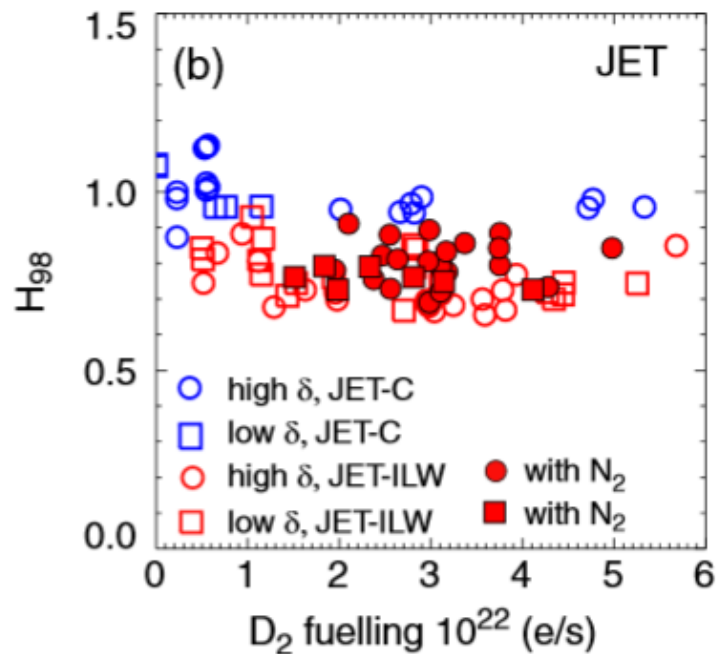

M. Beurskens and J. Schweinzer
NF2014

- Power degradation weaker than in IPB98(y,2) (as in AUG, DIII-D)
- With optimisation of plasma shape and fuelling, access to $H_{98(y,2)}=1$ at $\beta_N=1.8$ re-established

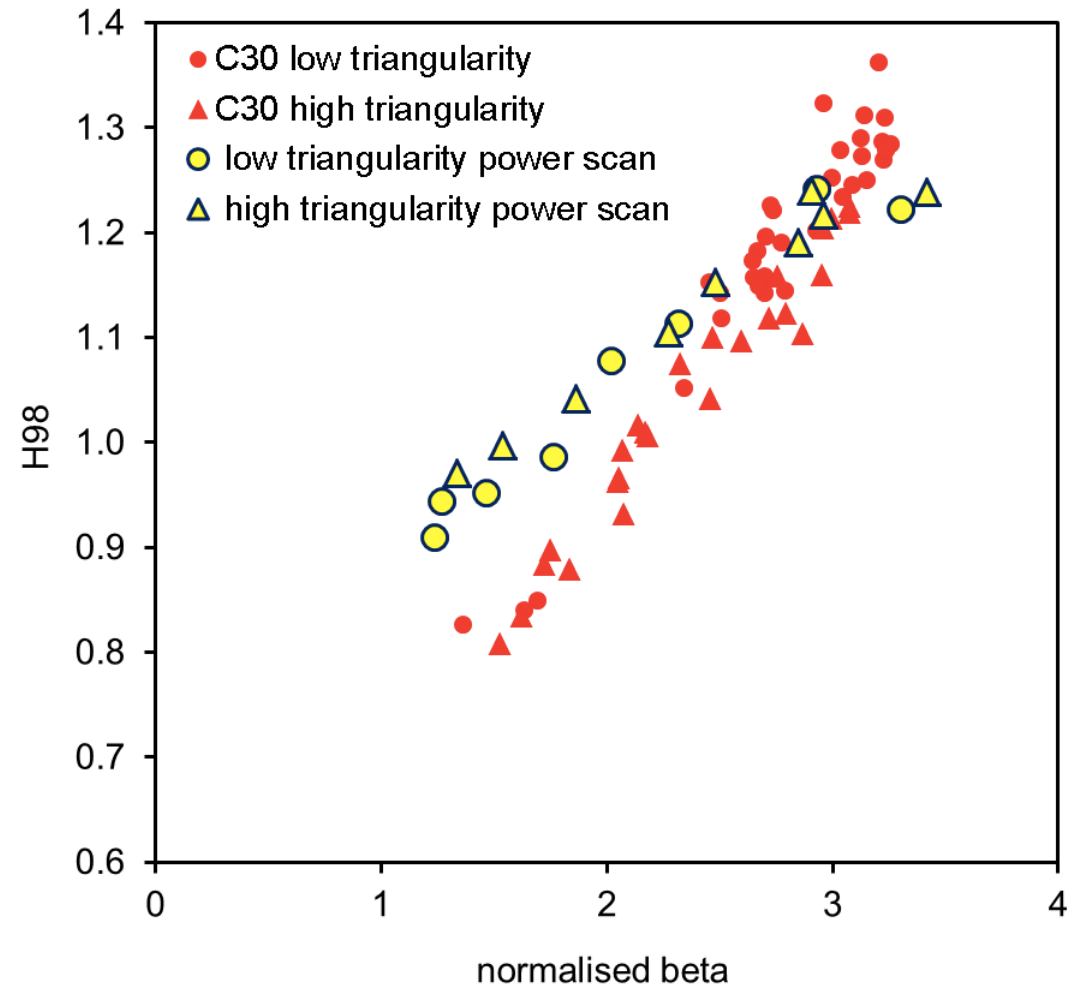

- What makes JET unique
- **Plans for JET exploitation**
- Potential areas for collaboration
- Summary

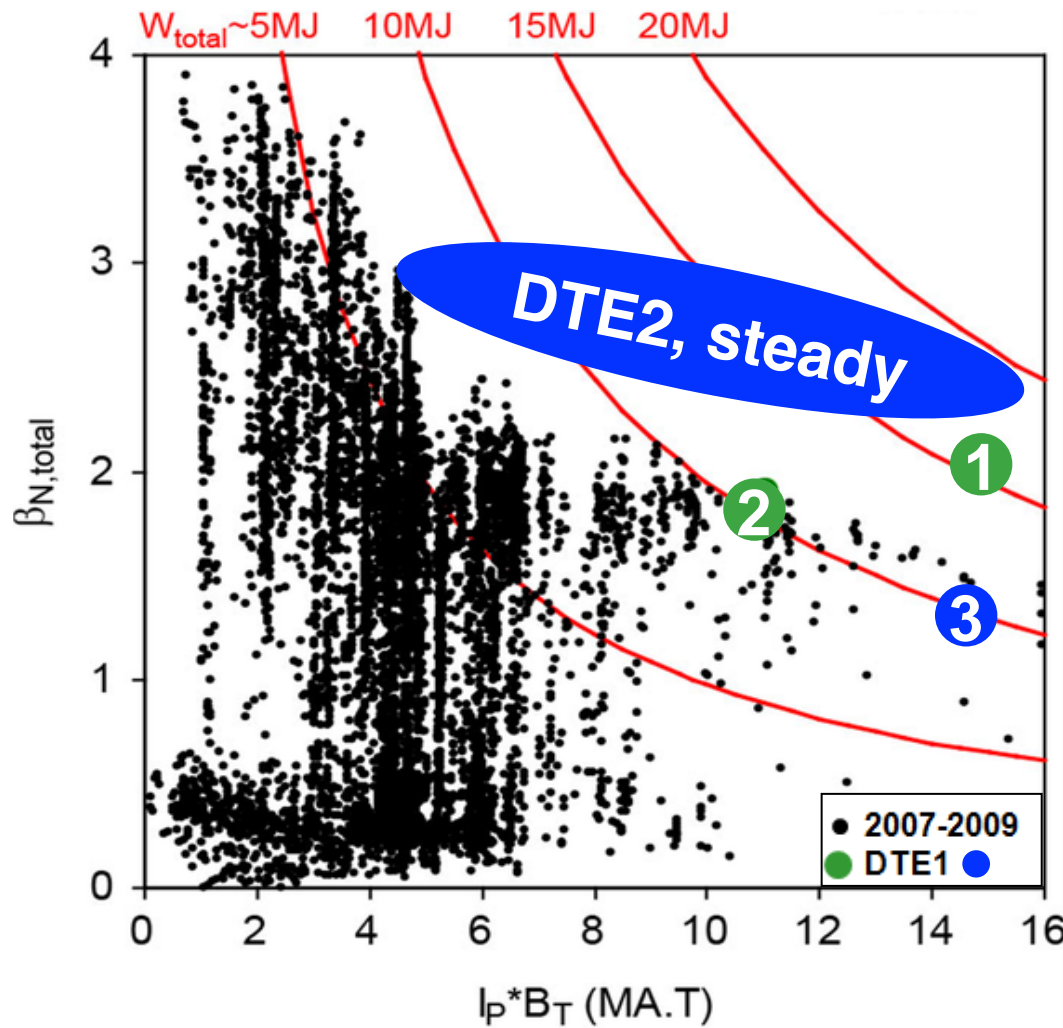

DTE1 scenarios:

- 1 Transient Hot-ion H-mode
- 2 Transient strong ITB
- 3 Steady ELMy H-mode

Substantial ITER scenario development since DTE1

Aim for sustained high fusion performance

Scenarios at high plasma beta ($\beta_N=2.5-3$) with their control requirements in DT (ITER regimes of operation).



- Plausible estimates range from pessimistic density assumption ($Q_{\text{total}} \sim 0.32-0.35$) to moderate density predictive simulation ($Q_{\text{total}} \sim 0.44$) with margin for higher I_p
- Realistic range of uncertainty : $Q_{\text{total}} \sim 0.3-0.5$

